

V = 38 m³, A: 9.940 mm, E: 3.290 mm, B: 8.600 mm, F: 1.750 mm

Wywrotka aluminiowa tylnozsypowa - kłapa zewnętrzna

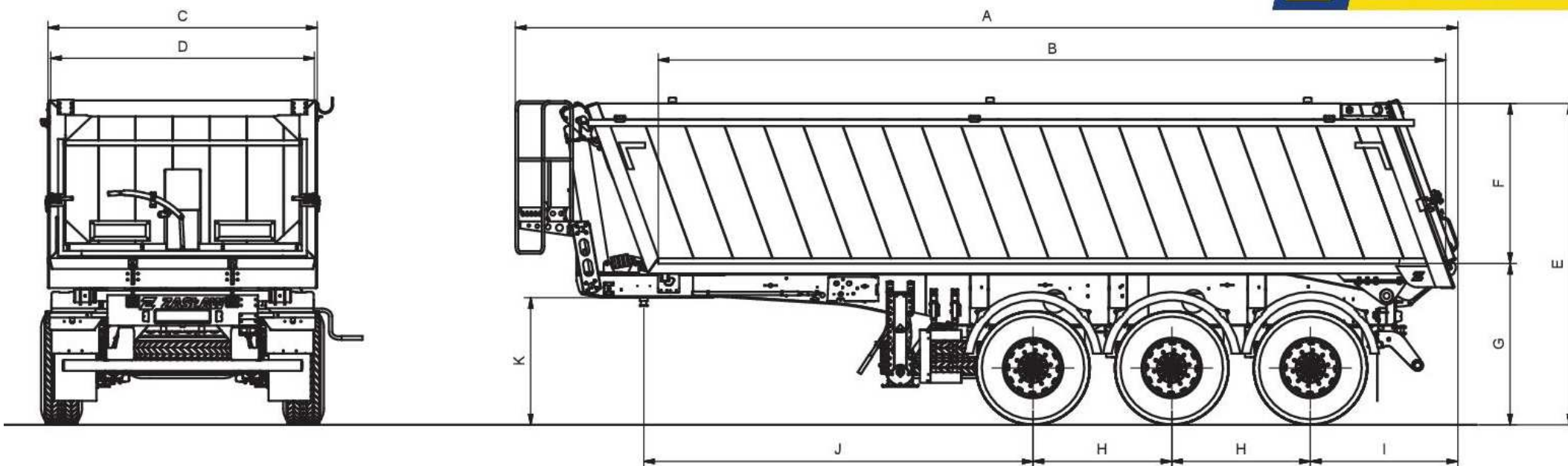

www.zaslaw-trails.pl / mail: info@zaslaw-trails.pl